

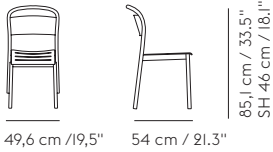

# LINEAR STEEL SIDE CHAIR

**THOMAS BENTZEN ON THE DESIGN** “The Linear Steel Side Chair brings new perspectives to modern outdoor furniture through its straight lines, folded edges and the contrast between its sturdy materiality and organic, soft form. The design is made unique by its half-circular intersecting legs and small spacing in the seat for easy removal of water, making the Linear Steel Side Chair visually clean for long-lasting aesthetics. The Linear Steel Side Chair is a stackable design in powder coated steel for a matte look and contemporary feel, paired with its subtle detailing for an elegant expression.”



49,6 cm / 19,5"    54 cm / 21,3"

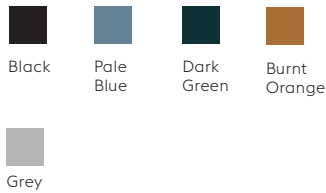

## DESIGNED BY / YEAR OF DESIGN

Thomas Bentzen / 2021

## ABOUT THE DESIGNER

Thomas Bentzen is a Copenhagen-based designer, working to infuse his designs with a refined simplicity. His studio was founded in 2010, creating designs that have received international recognition at fairs and exhibitions all over the world.

## CATEGORY

Chair

## ENVIRONMENT

Outdoor

## COUNTRY OF PRODUCTION

Italy

## ASSEMBLY REQUIRED

No

## DESCRIPTION

The Linear Steel Side Chair is designed with clean, elegant lines and subtle details for a modern expression. Linear Steel Side Chair stacks up to 5 chairs on the floor.

## MATERIAL

The chair is made from galvanized steel with a weather-resistant deep matt, UV-resistant powder coated finish, making the chair suitable for outdoor use. Plastic glides for outdoor use.

## CLEANING AND CARE

When cared for properly, the Linear Steel Series is designed to last. Follow these simple rules to care for your design in the best possible way. Clean the chair with a damp cloth after use. If necessary, use a mild detergent or dish-washing liquid, not concentrated. Always wipe with a dry cloth afterwards. To minimize the risk of stains and marks, liquids, grease etc. should be removed straight away.

Lacquered surfaces can get scratches and chips if hit by other hard objects. Be careful around the design when handling other hard objects, such as tableware and porcelain. In case of minor scratches in the paint, Muuto recommends that you contact your local DIY store, and get advice on which outdoor paint product they can recommend, to cover the minor scratches.

## Color codes:

Burnt orange: RAL 8001

Dark Green: RAL 6012

Black: RAL 7021

Grey: RAL 7044

Pale Blue: NCS 4020-B

## ACCESSORIES

Linear Steel Chair Sat Pad

## TEST & CERTIFICATIONS

EN 581-1 General safety and EN 581-2 Mechanical safety seating. Outdoor domestic and non-domestic

EN 1022 Domestic seating

EN 16139- LI General use Non-domestic seating



# LINEAR STEEL ARMCHAIR

**THOMAS BENTZEN ON THE DESIGN** “The Linear Steel Armchair brings new perspectives to modern outdoor furniture through its straight lines, folded edges and the contrast between its sturdy materiality and organic, soft form. The design is made unique by its half-circular intersecting legs and small spacing in the seat for easy removal of water, making the Linear Steel Armchair visually clean for long-lasting aesthetics. The Linear Steel Armchair is a stackable design in powder coated steel for a matte look and contemporary feel, paired with its subtle detailing and slender armrests for an elegant expression.”

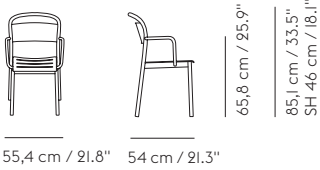

55,4 cm / 21.8"    54 cm / 21.3"

65,8 cm / 25.9"  
85,1 cm / 33.5"  
SH 46 cm / 18.1"

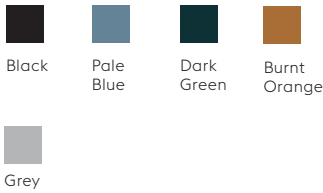

## DESIGNED BY / YEAR OF DESIGN

Thomas Bentzen / 2021

## ABOUT THE DESIGNER

Thomas Bentzen is a Copenhagen-based designer, working to infuse his designs with a refined simplicity. His studio was founded in 2010, creating designs that have received international recognition at fairs and exhibitions all over the world.

## CATEGORY

Chair

## ENVIRONMENT

Outdoor

## COUNTRY OF PRODUCTION

Italy

## ASSEMBLY REQUIRED

No

## DESCRIPTION

The Linear Steel Armchair is designed with clean, elegant lines and subtle details for a modern expression. Linear Steel Armchair stacks up to 5 chairs on the floor.

## MATERIAL

The chair is made from galvanized steel with a weather-resistant deep matt, UV-resistant powder coated finish, making the chair suitable for outdoor use. Plastic glides for outdoor use.

## CLEANING AND CARE

When cared for properly, the Linear Steel Series is designed to last. Follow these simple rules to care for your design in the best possible way. Clean the chair with a damp cloth after use. If necessary, use a mild detergent or dish-washing liquid, not concentrated. Always wipe with a dry cloth afterwards. To minimize the risk of stains and marks, liquids, grease etc. should be removed straight away.

Lacquered surfaces can get scratches and chips if hit by other hard objects. Be careful around the design when handling other hard objects, such as tableware and porcelain. In case of minor scratches in the paint, Muuto recommends that you contact your local DIY store, and get advice on which outdoor paint product they can recommend, to cover the minor scratches.

## Color codes:

Burnt orange: RAL 8001

Dark Green: RAL 6012

Black: RAL 7021

Grey: RAL 7044

Pale Blue: NCS 4020-B

## ACCESSORIES

Linear Steel Chair Sat Pad



# LINEAR STEEL BAR & COUNTER STOOL

THOMAS BENTZEN ON THE DESIGN “The Linear Steel Bar & Counter Stool brings new perspectives to modern outdoor furniture through its straight lines, folded edges and the contrast between its sturdy materiality and organic, soft form. The design is made unique by its half-circular intersecting legs and small spacing in the seat for easy removal of water, making the Linear Steel Bar & Counter Stool visually clean for long-lasting aesthetics. The Linear Steel Bar & Counter Stool is a stackable design in powder coated steel for a matte look and contemporary feel, paired with its subtle detailing for an elegant expression.”

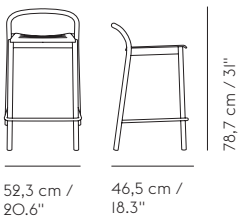

52,3 cm /  
20.6"

46,5 cm /  
18.3"

78,7 cm / 31"

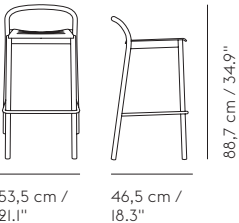

53,5 cm /  
21.1"

46,5 cm /  
18.3"

88,7 cm / 34.9"



Black



Pale  
Blue



Dark  
Green



Burnt  
Orange



Grey

## DESIGNED BY / YEAR OF DESIGN

Thomas Bentzen / 2021

## ABOUT THE DESIGNER

Thomas Bentzen is a Copenhagen-based designer, working to infuse his designs with a refined simplicity. His studio was founded in 2010, creating designs that have received international recognition at fairs and exhibitions all over the world.

## CATEGORY

Bar & Counter Stool

## ENVIRONMENT

Outdoor

## COUNTRY OF PRODUCTION

Italy

## ASSEMBLY REQUIRED

No

## DESCRIPTION

The Linear Steel Bar & Counter Stool is designed with clean, elegant lines and subtle details for a modern expression.

## MATERIAL

The Linear Steel Bar & Counter Stools are made from galvanized steel with a weather-resistant deep matt, UV-resistant powder coated finish, making the chair suitable for outdoor use. Plastic glides for outdoor use.

## CLEANING AND CARE

When cared for properly, the Linear Steel Series is designed to last. Follow these simple rules to care for your design in the best possible way. Clean the chair with a damp cloth after use. If necessary, use a mild detergent or dish-washing liquid, not concentrated. Always wipe with a dry cloth afterwards. To minimize the risk of stains and marks, liquids, grease etc. should be removed straight away. Lacquered surfaces can get scratches and chips if hit by other hard objects.

Lacquered surfaces can get scratches and chips if hit by other hard objects. Be careful around the design when handling other hard objects, such as tableware and porcelain. In case of minor scratches in the paint, Muuto recommends that you contact your local DIY store, and get advice on which outdoor paint product they can recommend, to cover the minor scratches.

## Color codes:

Burnt orange: RAL 8001

Dark Green: RAL 6012

Black: RAL 7021

Grey: RAL 7044

Pale Blue: NCS 4020-B

**MUUTO**

# LINEAR STEEL BENCH

THOMAS BENTZEN ON THE DESIGN “The Linear Steel Series was designed from the idea of presenting durable materials in a sophisticated and understated expression for outdoor use with its form language inspired by the notion of meetings—the meetings of lines, the meetings of shapes and the meetings of materials. The design is defined by its straight lines for a contemporary yet timeless aesthetic through the details of its folded edges, half-circular intersecting legs and small spacing for easy outflow of water. It is through these subtle elements that the Linear Steel Series translates the values of elegance, longevity and functionality into modern outdoor furniture.”

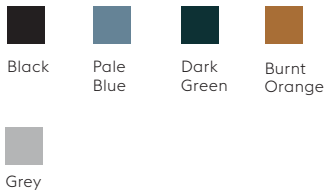
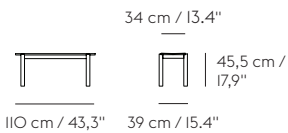
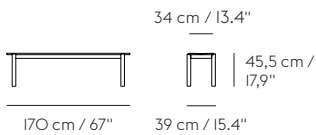

## DESIGNED BY / YEAR OF DESIGN

Thomas Bentzen / 2019

## ABOUT THE DESIGNER

Thomas Bentzen is a Copenhagen-based designer, working to infuse his designs with a refined simplicity. His studio was founded in 2010, creating designs that have received international recognition at fairs and exhibitions all over the world.

## CATEGORY

Outdoor Furniture

## ENVIRONMENT

Outdoor

## COUNTRY OF PRODUCTION

Sweden

## PREASSEMBLED

No

## DESCRIPTION

The Linear Steel Series brings new perspectives to modern outdoor furniture through its straight lines alongside the folded edges, half-circular intersecting legs and small spacing for easy removal of water. Kept visually clean for long-lasting aesthetics, the Linear Steel Series finds its distinct character through subtle detailing and a simple expression, allowing for it to complement any outdoor setting. The design is made in powder coated steel for a matte look and contemporary feel.

## MATERIAL

Frame and seat are made from steel with a weather-resistant deep matt, UV-resistant powder coated finish. Seat is aluzinc while legs are galvanized treated, making them suitable for outdoor use. Legs come with plastic glides.

## CLEANING AND CARE

When cared for properly, the Linear Steel Series is designed to last. Follow these simple rules to care for your design in the best possible way. Clean the bench with a damp cloth after use. If necessary, use a mild detergent or dish-washing liquid, not concentrated. Always wipe with a dry cloth afterwards. To minimize the risk of stains and marks, liquids, grease etc. should be removed straight away.

Lacquered surfaces can get scratches and chips if hit by other hard objects. Be careful around the design when handling other hard objects, such as tableware and porcelain. Never stack benches and tables on top of each other as hitting the surfaces against each other will cause lacquer to chip and scratch. In case of minor scratches in the paint, Muuto recommends that you contact your local DIY store, and get advice on which outdoor paint product they can recommend, to cover the minor scratches.

## Color codes:

Burnt orange: RAL 8001

Dark Green: RAL 6012

Black: RAL 7021

Grey: RAL 7044

Pale Blue: NCS 4020-B

To protect the Linear Steel Series from weather's harm when not in use, a cover can be purchased separately, allowing one to slide the benches under the table. Please make sure that both the piece of furniture and the inside of the cover is completely dry before putting the cover on.

## ACCESSORIES & SPARE PARTS

Linear Steel Bench Sat Pad  
Linear Steel Ground Mounting Kit  
Linear Steel Screws  
Glides for Linear Steel Bench

**MUUTO**



# LINEAR STEEL BENCH

## TEST & CERTIFICATIONS

ANSI/BIFMA X5.4 Lounge and Public Seating

EN 581-1 General safety and EN 581-2 Mechanical safety seating. Outdoor domestic and non-domestic

EN 1022 Domestic seating

EN 16139 - L2 Extreme use Non-domestic seating

# LINEAR STEEL CAFÉ TABLE



THOMAS BENTZEN ON THE DESIGN “The Linear Steel Café Table was designed from the idea of presenting durable materials in a sophisticated and understated expression for outdoor use with its form language inspired by the notion of meetings—the meetings of lines, the meetings of shapes and the meetings of materials. The design is defined by its straight lines for a contemporary yet timeless aesthetic, translating the values of elegance, longevity and functionality into modern outdoor furniture.”

## ABOUT THE DESIGNER

Thomas Bentzen is a Copenhagen-based designer, working to infuse his designs with a refined simplicity. His studio was founded in 2010, creating designs that have received international recognition at fairs and exhibitions all over the world.

## CATEGORY

Table

## ENVIRONMENT

Outdoor

## COUNTRY OF PRODUCTION

Italy

## DESCRIPTION

The Linear Café Table is characterized by its clean lines and elegant shapes, allowing for it to complement any outdoor setting

## MATERIAL

The tabletop and base are made from galvanized steel with a weather-resistant deep matt, UV-resistant powder coated finish, making the table suitable for outdoor use. Plastic glides for outdoor use.

## CLEANING AND CARE

When cared for properly, the Linear Steel Series is designed to last. Follow these simple rules to care for your design in the best possible way. Clean the table with a damp cloth after use. If necessary, use a mild detergent or dish-washing liquid, not concentrated. Always wipe with a dry cloth afterwards. To minimize the risk of stains and marks, liquids, grease etc. should be removed straight away.

Lacquered surfaces can get scratches and chips if hit by other hard objects. Be careful around the design when handling other hard objects, such as tableware and porcelain. Never stack tables on top of each other as hitting the surfaces against each other will cause lacquer to chip and scratch. In case of minor scratches in the paint, Muuto recommends that you contact your local DIY store, and get advice on which outdoor paint product they can recommend, to cover the minor scratches.

## Color codes:

Burnt orange: RAL 8001  
 Dark Green: RAL 6012  
 Black: RAL 7021  
 Grey: RAL 7044  
 Pale Blue: NCS 4020-B

## TEST & CERTIFICATIONS

ANSI/BIFMA X5.5 Desk Products

EN 581-1 General safety and EN 581-3 Mechanical safety tables. Outdoor domestic and non-domestic

EN 15372 - L3 Severe use. Non-domestic tables

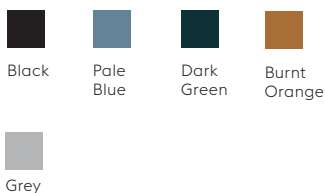
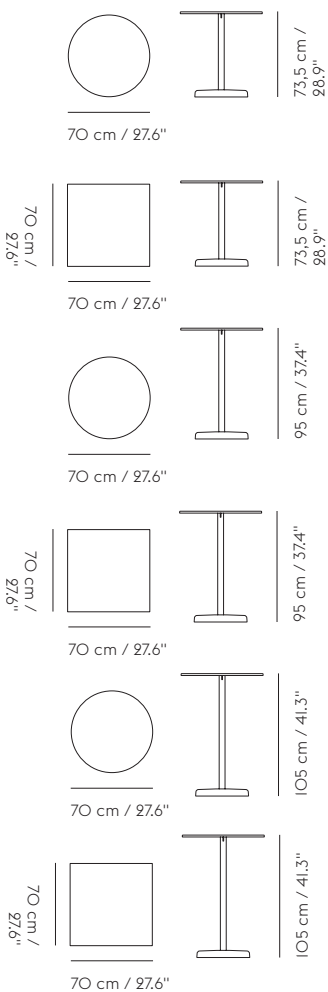



# LINEAR STEEL TABLE

**THOMAS BENTZEN ON THE DESIGN** “The Linear Steel Series was designed from the idea of presenting durable materials in a sophisticated and understated expression for outdoor use with its form language inspired by the notion of meetings—the meetings of lines, the meetings of shapes and the meetings of materials. The design is defined by its straight lines for a contemporary yet timeless aesthetic through the details of its folded edges, half-circular intersecting legs and small spacing for easy outflow of water. It is through these subtle elements that the Linear Steel Series translates the values of elegance, longevity and functionality into modern outdoor furniture.”

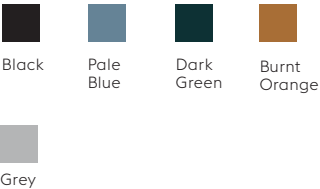
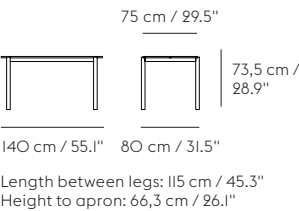
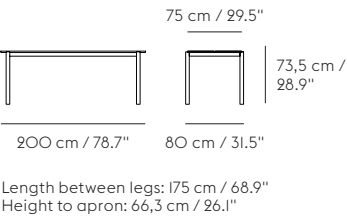
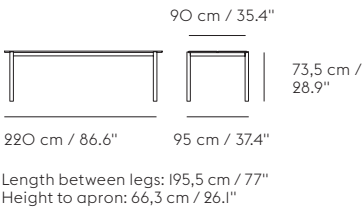

## DESIGNED BY / YEAR OF DESIGN

Thomas Bentzen / 2019

## ABOUT THE DESIGNER

Thomas Bentzen is a Copenhagen-based designer, working to infuse his designs with a refined simplicity. His studio was founded in 2010, creating designs that have received international recognition at fairs and exhibitions all over the world.

## CATEGORY

Outdoor Furniture

## ENVIRONMENT

Outdoor

## COUNTRY OF PRODUCTION

Sweden

## PREASSEMBLED

No

## DESCRIPTION

The Linear Steel Series brings new perspectives to modern outdoor furniture through its straight lines alongside the folded edges, half-circular intersecting legs and small spacing for easy removal of water. Kept visually clean for long-lasting aesthetics, the Linear Steel Series finds its distinct character through subtle detailing and a simple expression, allowing for it to complement any outdoor setting. The design is made in powder coated steel for a matte look and contemporary feel.

## MATERIAL

Frame and table top are made from steel with a weather-resistant deep matt, UV-resistant powder coated finish. Table top is aluzinc while legs are galvanized treated, making them suitable for outdoor use. Legs come with plastic glides.

## CLEANING AND CARE

When cared for properly, the Linear Steel Series is designed to last. Follow these simple rules to care for your design in the best possible way. Clean the bench with a damp cloth after use. If necessary, use a mild detergent or dish-washing liquid, not concentrated. Always wipe with a dry cloth afterwards. To minimize the risk of stains and marks, liquids, grease etc. should be removed straight away.

Lacquered surfaces can get scratches and chips if hit by other hard objects. Be careful around the design when handling other hard objects, such as tableware and porcelain. Never stack benches and tables on top of each other as hitting the surfaces against each other will cause lacquer to chip and scratch. In case of minor scratches in the paint, Muuto recommends that you contact your local DIY store, and get advice on which outdoor paint product they can recommend, to cover the minor scratches.

## Color codes:

Burnt orange: RAL 8001

Dark Green: RAL 6012

Black: RAL 7021

Grey: RAL 7044

Pale Blue: NCS 4020-B

To protect the Linear Steel Series from weather's harm when not in use, a cover can be purchased separately. Please make sure that both the table and the inside of the cover is completely dry before putting the cover on.

## ACCESSORIES & SPARE PARTS

Linear Steel Cover

Linear Steel Ground Mounting Kit

Linear Steel Screws

Glides for Linear Steel Table



## LINEAR STEEL TABLE

### TEST & CERTIFICATIONS

EN 15372:2016 - L3: Extreme use  
Furniture – Strength, durability and safety –  
Requirements for non-domestic tables

EN 581-1:2017 - Part 1: General safety requirements  
Outdoor furniture – Seating and tables for  
camping, domestic and contract use

EN 581-3:2017 - Part 1: Mechanical safety requirements for tables.  
Outdoor furniture – Seating and tables for  
camping, domestic and contract use